

USER MANUAL – USA Version

LDR 8 s Auto Clean

LDR 8+8 s Auto Clean



WARNING

Read the instructions before using the machine.

KEEP THIS USER MANUAL IN A SAFE PLACE FOR FUTURE USE

© 2024 Fri-Jado B.V., Oud Gastel, The Netherlands.

We advise you to contact your supplier for the guarantee period and conditions. Further we refer to our General Terms and Conditions for Sales and Delivery that are available upon request.

The manufacturer does not accept any liability for damage or injury caused by failing to adhere to these regulations or by not observing the usual caution or care in actions, operation, maintenance or repair activities, even if not explicitly described in this manual.

As a result of constant commitment to improvement, it may happen that your unit deviates in detail from what is described in this manual. For this reason, the given instructions are only a guideline for the installation, use, maintenance and repair of the unit referred to in this manual. This manual has been composed with the utmost care. The manufacturer shall, however, not be held responsible for any mistakes in this manual nor for any consequences thereof. The user is allowed to copy this manual for own use. Further all rights are reserved and nothing in this manual may be reproduced and/or made public in any way.

Modifications:

In case of unauthorized modifications in or on the unit, every liability on the part of the manufacturer becomes null and void.

CONTENTS

1.	INTRODUCTION	5
1.1	General.....	5
1.2	Identification of the unit.....	5
1.3	Pictograms and symbols.....	5
1.4	Safety instructions	6
1.4.1	General.....	6
1.4.2	Moving.....	7
1.5	Hygiene	7
1.6	Service and technical support.....	7
1.7	Storage.....	7
1.8	Disposal.....	7
2.	DESCRIPTION OF THE UNIT	8
2.1	Technical description	8
2.2	Intended use.....	8
2.3	Accessories	8
3.	INSTALLATION AND FIRST USE	9
3.1	Unpacking the unit	9
3.2	Installation and positioning.....	10
3.3	First use.....	11
3.3.1	Metal odor	11
4.	OPERATION AND USE	12
4.1	Control Panel.....	12
4.2	Switching-on the unit.....	13
4.3	Loading the unit	13
4.3.1	Loading the rotisserie using V-shape spits (accessory)	13
4.3.2	Loading the rotisserie using meat baskets (accessory).....	13
4.4	Grilling time.....	14
4.5	Taking out the products	14
4.5.1	Taking out the V-shape spit (accessory)	15
4.5.2	Taking out the meat basket (accessory)	15
4.6	Emptying grease container / grease caddy (optional).....	15
4.7	Switching-off the unit.....	15
5.	OPERATE	16
5.1	Starting a program	16
5.2	Delayed starting time (optional)	16
5.3	Pre-heating.....	17
5.4	While cooking	17
5.5	Adding extra time to the active program.....	18
5.6	Interrupt a program	18
5.7	Reset alarm signal	18

5.8	Power down	18
5.9	Cooking Correction (manager only)	19
6.	SETTINGS.....	20
6.1	General.....	20
6.2	Overview main parameters (Manager).....	20
6.3	Service Menu.....	20
7.	PROGRAM.....	21
7.1	General.....	21
7.2	Adding programs	21
7.3	Edit programs	21
7.4	Deleting programs	22
8.	CLEANING AND MAINTENANCE	23
8.1	Maintenance schedule	23
8.2	Daily Cleaning.....	23
8.3	Weekly Cleaning.....	25
8.4	Additional Manual Cleaning	25
9.	MALFUNCTIONS AND SERVICE	26
9.1	Replace the mains cord	26
10.	TECHNICAL SPECIFICATIONS	27

1. INTRODUCTION

1.1 General

This manual is intended for the user of the LDR 8 s AC (Large Deli Rotisserie with cleaning feature). The features and controls are being described, along with directions for the safest and most efficient use, in order to guarantee a long life of the unit.

All pictograms, symbols and drawings in this manual apply to all LDR 8 s AC (USA) models.

1.2 Identification of the unit

The identification plate can be found on the outside of the machine, and contains the following data:

- Name of the supplier or the manufacturer.
- Model.
- Serial number.
- Year of construction.
- Voltage.
- Frequency.
- Power consumption.

1.3 Pictograms and symbols

In this manual, the following pictograms and symbols are used:



WARNING

Possible physical injury or serious damage to the unit, if the instructions are not carefully followed.



WARNING

Hazardous electrical voltage.



WARNING

Danger of getting injured by hot surfaces.



Suggestions and recommendations to simplify indicated actions.



Recycling symbol.



Direction of view symbol.

1.4 Safety instructions



WARNING

The outside of the unit can be very hot.



WARNING

The maximum load on top of the unit may never exceed 110 lbs.



WARNING

Risk of slippery floor: Spills may cause slippery surfaces, clean-up promptly.



WARNING

See installation instructions for grounding requirements.



WARNING

Always use the brakes on both front wheels:



1.4.1 General

The user of the unit will be fully responsible for abiding the locally prevailing safety- rules and regulations.

The unit may be operated by qualified and authorized persons only. Anyone working on or with this unit must be familiar with the contents of this manual and carefully follow all guidelines and instructions. Never change the order of the steps to be performed. The management must instruct the personnel on the basis of this manual and follow all instructions and regulations.

The pictograms, labels, instructions and warning signs attached to the unit, are part of the safety measures. They may never be covered or removed, and have to be clearly visible during the entire lifetime of the unit.

Immediately repair or replace damaged or illegible pictograms, warnings and instructions.

- To avoid short-circuiting, never clean the unit using a water hose. For cleaning instructions, see section 8.
- During the grilling process, the unit can get very hot.
- When the door is opened the rotor stops and the heater is de-energized.
- The unit must be cleaned daily after use to ensure proper functioning and prevent fire hazard (over heating).
- Stacked units - Do not process food (e.g. grilling) in one unit while auto-clean the other unit.
- The fat collecting container must be emptied regularly, to prevent overflow.
- This appliance can be used by children aged from 8 years and above and persons with reduced physical, sensory or mental capabilities or lack of experience and knowledge if they have been given supervision or instruction concerning use of the appliance in a safe way and understand the hazards involved.
- Children shall not play with the appliance.
- Cleaning and user maintenance shall not be made by children without supervision.

1.4.2 Moving

When moving the unit:

- Before moving the unit, first switch off the mains voltage by pulling the plug from the wall socket and empty the fat collecting container. After that, cool-down the unit for at least ten minutes.
- Disconnect the water supply and drain.
- Stacked units (8+8): remove the fat collecting container.
- Units equipped with wheels are not suited to pass ledges or obstacles higher than 0.4 inch.
- When moving the unit, always push at the center of the unit. Never on top. Never at the bottom.
- Make sure that the wheels can move freely, so they never touch the gas hose and/or the power lead.

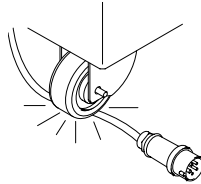

1.5 Hygiene

The quality of a fresh product always depends on hygiene. Especially grilling products. With the risk of salmonella contamination – especially for chicken products – you must make sure that grilled products can never be mixed with uncooked products. Also contact between grilled products and hands or tools that have been in contact with raw chicken meat, must be avoided at all times.

Hands or tools that have been in contact with raw chicken meat, must be cleaned thoroughly.

1.6 Service and technical support

The electrical schematics of your unit is included. In case of malfunctions you can contact your dealer/service agent. Make sure you have the following data available:

- Model.
- Serial number.

This data can be found on the identification plate.

1.7 Storage

If the unit will not be used temporarily, and will be stored, follow these instructions:

- Disconnect power supply.
- Disconnect water supply.
- Clean the unit thoroughly.
- Wrap the unit from getting dusty.
- Store, when applicable, the unit in a dry, non-condensing environment.

1.8 Disposal



Dispose of the machine, any components or lubricants removed from it safely in accordance with all local and national safety and environment requirements.

2. Description of the unit

2.1 Technical description

The LDR 8 s AC uses natural convection and fans to provide an equally divided heat. The hardened glass panes are equipped with a heat reflecting layer to keep the heat inside the grill. The rotor is being wheeled by a maintenance-free motor and gearbox.

The plating of the unit is made of stainless steel. The product contact parts are made of stainless steel AISI 304. The mains cable is provided with a plug.

The intelligent control keeps the temperature inside the unit fixed to level set by the operator. During the entire process, the interior of the unit will be illuminated by halogen lamps. The intelligent control has a capability to store many different programs. Each program can consist of a pre-heat and additional steps in which the cooking time and temperature can be set. Communication through USB / WIFI (optional) enables easy read-out, re-work and creating of programs via a PC. For this, special software is available at Fri-Jado.

The unit has an automated cleaning program that cleanses the unit.

2.2 Intended use

The unit has been designed for grilling meat products and has a semi self-cleaning feature. Any other use will not be regarded as intended use.

The manufacturer accepts no liability whatsoever for loss or injury caused by failing to strictly adhere to the safety guidelines and instructions in this manual or due to carelessness during installation, use, maintenance and repair of the unit referred to in this manual and any of its accessories.

Use the unit in perfect technical condition only.

2.3 Accessories

Your unit contains the following standard accessories:

- User manual.

For optional accessories contact customer.service@frijado.com.

3. INSTALLATION AND FIRST USE



All packing materials used for this unit are suited for recycling.

After unpacking, check the state of the unit. In case of damage, store the packing material, and contact the transporter within fifteen working days after receiving the goods.

3.1 Unpacking the unit

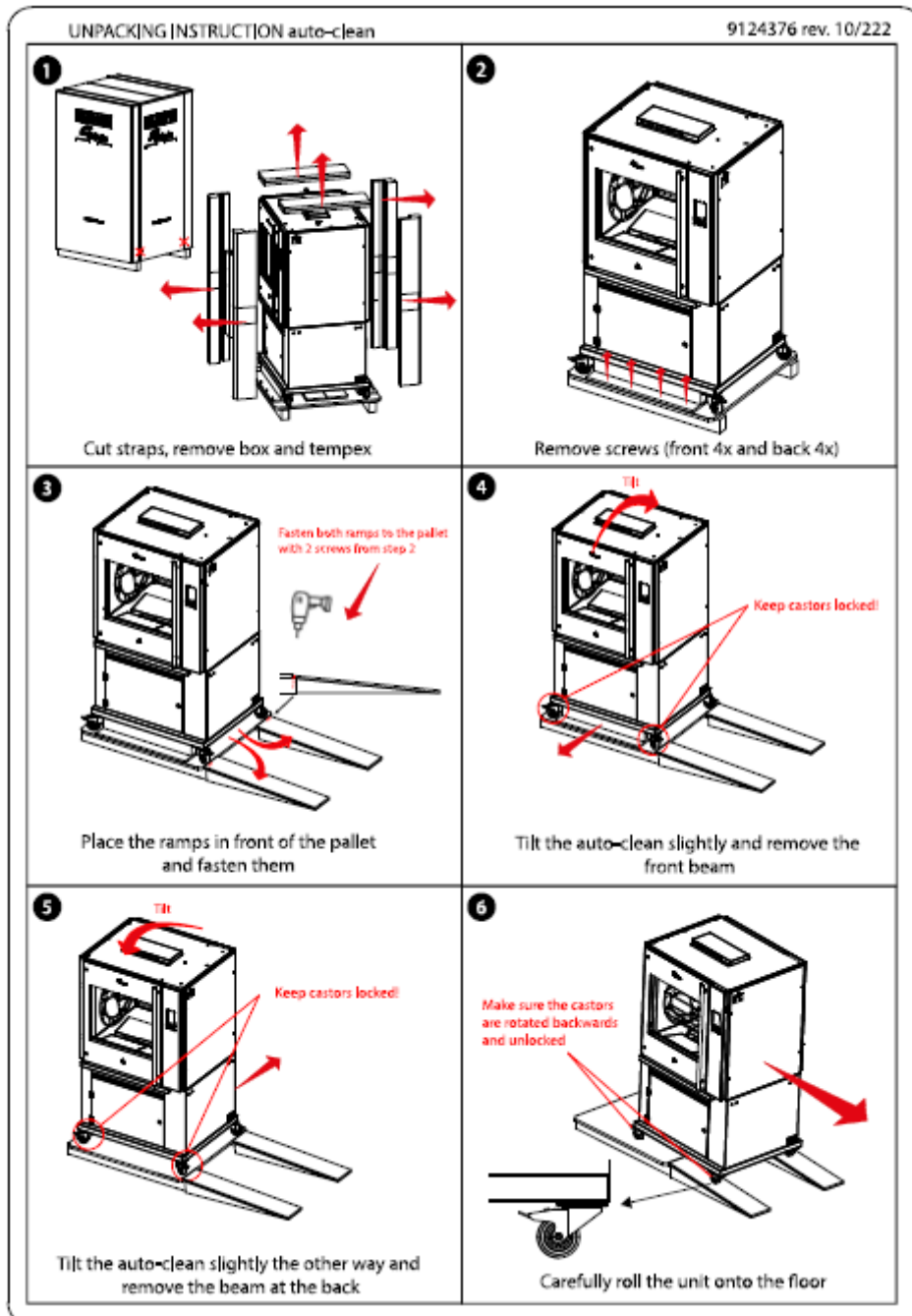

(Single unit shown)

1. Unpack the unit as initiated on the unpacking instruction on the packaging.
2. Remove all remaining packing materials from the unit.
3. Remove the protective foil from the metal parts.
4. Take off the standard accessories.

3.2 Installation and positioning

WARNING

Electric shock hazard. Grounding instructions: only connect the appliance to an alternating current provided by a grounded wall socket, with a mains voltage in accordance with the information indicated on the data plate of the appliance.

It is the consumer's responsibility to make sure the electrical installation conforms with current national and local codes and wiring regulations.

Do not use a multi plug or extension cord. Such can result in fire, electrical shock, or other personal injury.

Failure to follow these instructions can result in death or serious injury.

WARNING

Position the unit on a flat and horizontal surface. A temporally inclined plane of maximum 5° is allowed.

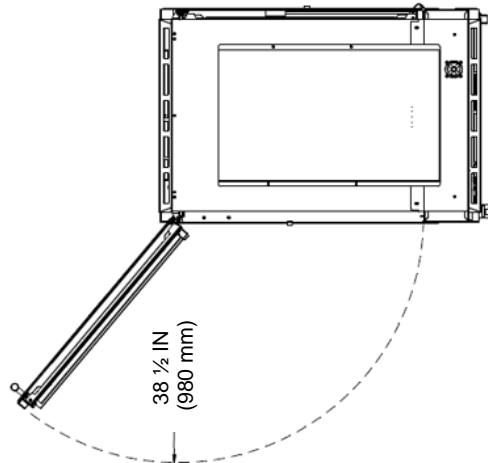
Positioning:

- The user must have sufficient freedom of movement to properly operate the unit.
- The ambient temperature of the unit must be between 50°F and 86°F.
- Use proper lifting– and transport tools to move the unit.
- Place the unit, using a spirit level, flat on a solid surface. Mind the weight of the unit!
- The minimum free distance must be at least 4 inch.
- Keep a distance of at least 20 inch of free space above the unit.
- The products inside the unit must be clearly visible.
- Keep children away from the operating side of the unit.
- During grilling, the glass panes will get very hot. While positioning, keep the unit out of children's reach.
- Appliance is for use only with the specific legs or casters specified by the manufacturer.
- In case of a wheeled unit, the floor must be flat and leveled.

Installation:

- Secure the unit to the building structure using the tether bracket, refer to the installation manual.
- A water connection with an aerated valve with a 3/4 inch thread connection, with a minimum continuous flow rate of 15 liters / min, must be available near the unit. The water pressure must be between 200 and 500 kPa (2 and 5 bar), preferably at least 300 kPa (3 bar). Refer to the installation manual.
- Use the water hose supplied with the machine.
- An open drainage with a diameter of at least 1.6 inch must be available near the unit.
- The unit has fixed wiring and must be connected by a certified electrician.

3.3 First use

When using the unit for the first time, clean the interior thoroughly with soap suds and heat up the unit, see section 3.3.1. After commissioning discoloration of the cooking/grilling area can occur.

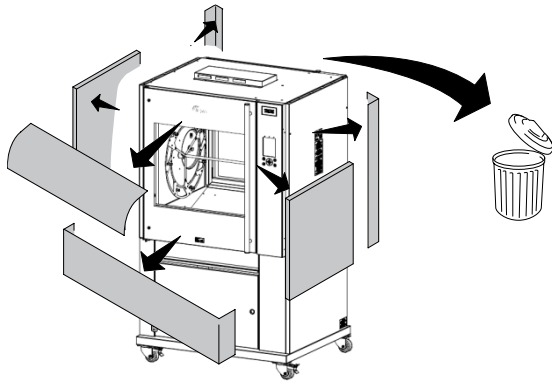
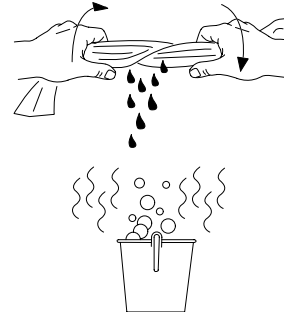
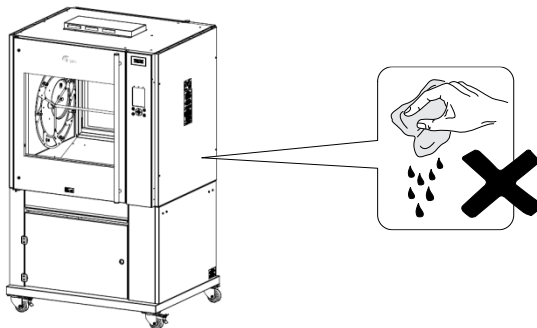
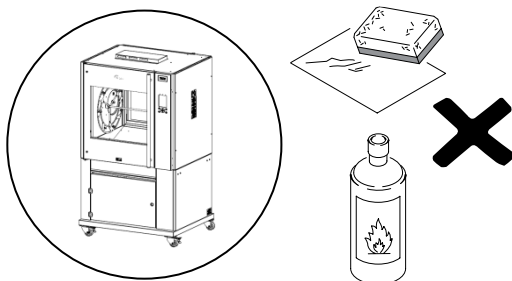
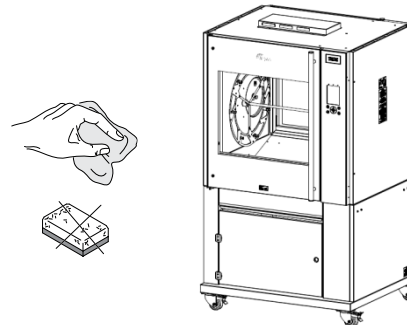

1

2

3

4

5

3.3.1 Metal odor

To remove the metal odor that will appear at first use, the unit must be heated at the maximum temperature (428°F) for at least half an hour.

1. Tap on the control screen and switch-on the unit.



2. Press  to display the recipe screen.
3. Create a new program containing ONE step of maximum temperature and a duration of at least 30 minutes (See section 7).
4. Select the new program and press  to start (See section 5).
5. Allow the unit to fully execute the program.

The unit is now ready for use.

4. OPERATION AND USE

4.1 Control Panel



Main Functions:



ON / OFF



Recipes



Wipe/clean touch screen (during countdown)



Clean Rotisserie



Home screen



Language



Help function



Tap or swipe to select function or activate additional screen



Step Back (when shown at upper left corner)

4.2 Switching-on the unit



4.3 Loading the unit

When the door is open press the rotor button  to activate the rotor. This allows easy loading or unloading of the products.

Whilst loading the unit, make sure that the rotor gets evenly loaded, so that the mass of the products is evenly spread over the rotor, causing an equal balance. Do not allow empty meat forks, meat baskets and chicken racks etc. in the grilling process.

4.3.1 Loading the rotisserie using V-shape spits (accessory)

If you are using V-shape spits act as follows:

- Place the skewer into the small outside hole on the rotor end plate on your left (as you face the oven). The back of the V-shape spit should be pointing towards you.



- Fit the other end of the spit into the small corresponding holes on the rotor end plate on your right (as you face the oven).
- Make sure the spit is level. If the spit is not level, make sure you are using the correct holes on the rotor end plates.

4.3.2 Loading the rotisserie using meat baskets (accessory)

If you are using meat baskets, act as follows:

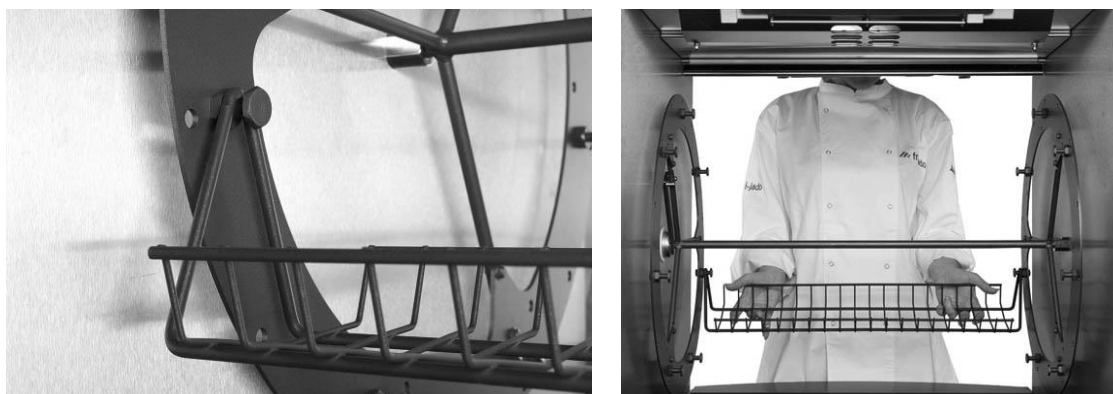

- Whilst loading the unit with meat baskets, you must see to it, that the rotor gets evenly loaded, so that the mass of the products is evenly spread over de rotor, causing an equal balance.
- Also see to it that no meat parts are sticking out of the baskets.

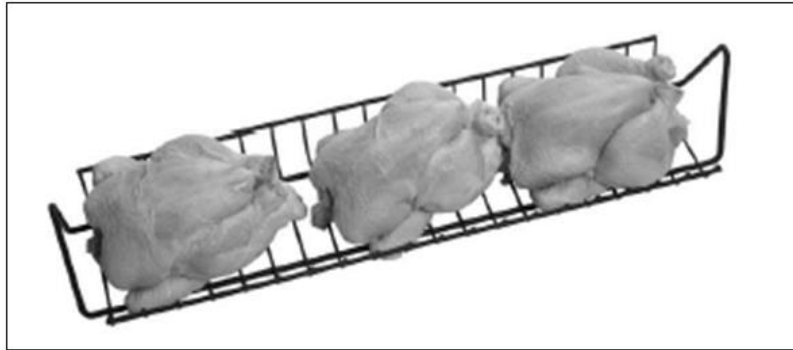

4.4 Grilling time

Grilling time depends on a number of factors:

- The ambient temperature and draft in the direct vicinity of the unit.
- Grilling temperature.
- The initial product temperature.
- The sort of meat (fat or lean) and with or without additives.
- The mass and shape of the product.
- The total amount of meat to be grilled in one grilling cycle.
- The end result.



Seasonings

The use of herbs and seasoning adds a specific twist to every meal. Using them right is of great importance for the end result.

Guidelines for seasoning are:

- Preferably use the special chicken and meat seasonings of the supplier of the Fri-Jado Grill. There are special seasoning mixtures for poultry, lamb, pork, large meat, game and fish.
- Season the products to be grilled when dry.
- Season the products 90 minutes before grilling at the most to prevent the spices from abstracting too much fluid from the meat.
- Do not add oil or grease while grilling.
- Season chicken on the inside and on the outside.

4.5 Taking out the products



WARNING

After the grilling, the interior of the unit and the glass panes are very hot. Always use oven gloves when taking out the meat forks or other accessories.

4.5.1 Taking out the V-shape spit (accessory)

When taking out the V-shape spit, it is best to act as follows:

1. Hold the V-shape spit firmly.
2. Slightly lift the end with the grips and shift the spit into the direction of its point. This releases the spit.
3. Take the spit at its other end and take it out of the unit.
4. Remove the products from the spit.



Refer to the You-Tube movie: “Fri-Jado instruction for unloading chicken from a rotisserie”.

4.5.2 Taking out the meat basket (accessory)

When taking out the meat basket from the LDR it is best to act as follows:

1. Slightly lift both ends of the meat basket.
2. Move the basket towards either the left or right hand side of the unit. This action unlocks one end of the basket.
3. Move the unlocked end towards you and take out the basket from the unit.

Depending on the number of prepared products you may have to empty the baskets before they can be removed.

4.6 Emptying grease container / grease caddy (optional)



WARNING

Check the grease container / caddy after each cooking process and empty already when about half full to avoid overflowing.



WARNING

Grease will be hot immediately after cooking. Allow grease to cool or use extreme caution and wear insulated gloves or safety mitts.

Single Units:

1. Disconnect power (caddy unit).
2. Take the grease container / caddy out.
3. Empty the container / caddy.
4. Place the (emptied) container / caddy back.
5. Connect power (caddy unit).

Stacked Units:

1. Take the grease drawer out.
2. Empty the drawer.
3. Place the (emptied) drawer back.

4.7 Switching-off the unit



5. OPERATE

5.1 Starting a program



1. Press .
2. Select the required program. The total duration of the program is shown in minutes next to the program name.



3. Press .



5.2 Delayed starting time (optional)

When the Delayed starting time function is activated (at manager menu), a delayed starting time can be set.

1. Press the start delay icon .



2. Set the desired start time .



3. Press .
4. Select the required program.



5. Press .
6. Check start time. To confirm, press **Continue**.
7. Check: Change fat container. Press **Continue** when executed.
8. Start delay time is set, program starts automatically at the set time.

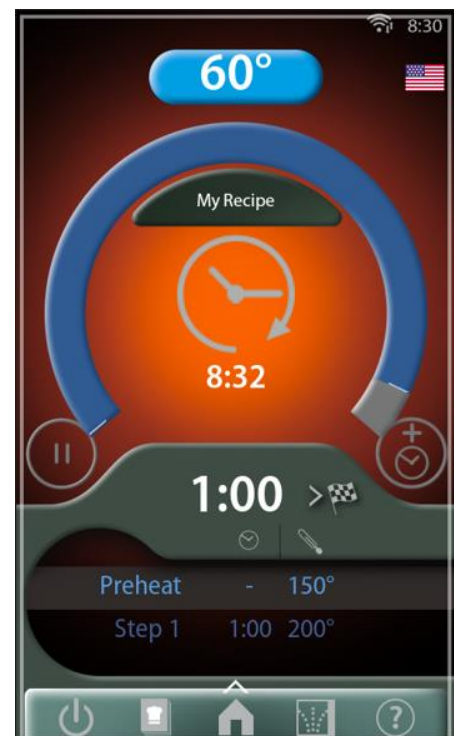

5.3 Pre-heating

When the pre-heat function is activated (at manager menu), the unit will start this function after selecting a program.

The screen will display the actual temperature (at the top).

Tap on the temperature box to see the set pre-heat temperature (approx. 5 sec.).

When the set temperature is reached, the screen will show: "Preheat done. Waiting for oven to be loaded" and a sound is activated.

Load the rotisserie and press .

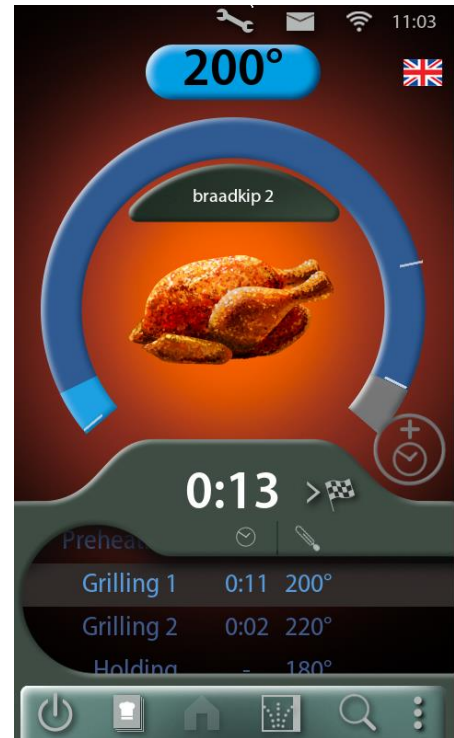

5.4 While cooking



WARNING

Opening the door during a grilling program or a cleaning program causes the unit to stop and a warning is shown.

The unit will continue when the door is closed and  pressed.

During the cooking process, the display shows a graph with the:

- planned trajectory (dark blue time line).
- processed trajectory (light blue time line).
- program steps (white stripe).
- and the set temperature (at the top).

In the center the graph, the program name, current function and remaining time are shown.

In the bottom of the screen the process steps are given.

The screen will display the set temperature (at the top). Tap on the temperature box to see the actual temperature (approx. 5 sec.).

When 'cook correction' is switched-on the remaining time will be automatically adjusted.

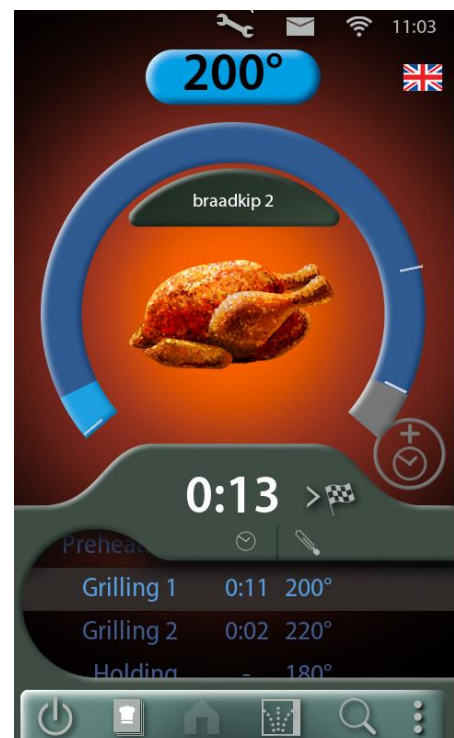

5.5 Adding extra time to the active program

During the process extra time can be added (when activated in the manager menu), by following the next steps:



1. Press .
2. Set extra time.
3. Select  to save setting.

The display now shows the extra time, which will be added to the last cooking step. The screen always shows the total amount of extra time.

5.6 Interrupt a program

Interrupt temporarily:

1. Press .
2. Press  to resume the program.

Interrupt definitely:

Press  and press on Cancel Receipt.

5.7 Reset alarm signal

When an alarm signal has been set, a message will occur. Press  to return to the main menu.

5.8 Power down

If no program is active and no key is touched within the next 60 minutes the unit will switch-off automatically.

This option can be both switched-off or adjusted by a service engineer.

5.9 Cooking Correction (manager only)

It is possible to set a cooking correction in a program. This function adjusts the cooking time of the program based on the internal temperature to assure the same result is obtained as a reference run. With this function the quality of the products will remain constant regardless of quantity of the load, initial temperature of the load and age of the unit.

The cooking correction function is set to “on” by default and can be changed by the service mechanic.

Note: If cooking correction is enabled but no reference program is available, the program will run according to its original settings and will not correct itself.

Creation of a reference of the program:

1. Make a program (see chapter 7)
 - It may be required to experiment to determine the parameters for obtaining the desired result.
Take into account:
 - Temperature
 - Time
 - Load of the unit. It is recommended to load for 75%.
2. Once all the parameters have been determined and the program has been updated to obtain the desired result, the reference program can be stored.
3. Open the manager settings menu.
4. Select the function “reference cook”.
5. Select the program.
 - Programs that already have a reference will have the pictogram: 
6. Load the unit the same amount as determined in step 1.
7. Start the program.
8. After the program has been completed, the reference point will be set automatically.

6. SETTINGS

6.1 General

The settings of the unit can be changed by using the control panel. There are three kinds of settings:

- Information.
- Manager.
- Service.



Select  to enter the setting menu.

The Manager and Service section are password protected.



Press  to go one level back.

6.2 Overview main parameters (Manager)

Setting	Function and values
Change pin code	• 0000 – 9999 Setting the pin code for access to the Manager Menu. This pin code can also be used for access to the Program Menu.
Toggle light	• ON – OFF
Temperature unit	• °C – °F
Volume unit	• Lit – Gal
UTC Time	• Setting the current time (UTC Time)
UTC Date	• Setting the current date (UTC Date)
Time zone offset	• -/ - 12 – +/ + 12
Time format	• 24h – AM/PM
Date format	• D/M/Y – M/D/Y
Start delay recipe	• ON – OFF
Alarm	• YES – NO
End-user recipe editing	• NO – YES
Ask weight	• NO – YES
Preheat mode	• NO – 1x – continues
Preheat temp default	• 68 – 302°F (Factory setting at 302°F)
Eco function	• NO – YES
Audio settings	• 1 – 11
Audio factor	• 1 – 100
Test audio	
Sound set	• Marimba – Bell – Beeper
Keyboard beep	• OFF – ON
Filter capacity	• 50 – 30000, or “0” for infinite
Lime filter	Remaining capacity of lime filter
Lime filter replaced	• NO – YES
Clean screen time	• 10 – 60 sec
Store Number	
Reference cook	
Recipes -> USB	
Recipes <- USB	
I+ recipes<-USB	
Add recipes<-USB	

6.3 Service Menu

The service menu contains settings for the security of the unit. This can only be accessed by the supplier or a service technician.

7. PROGRAM



7.1 General

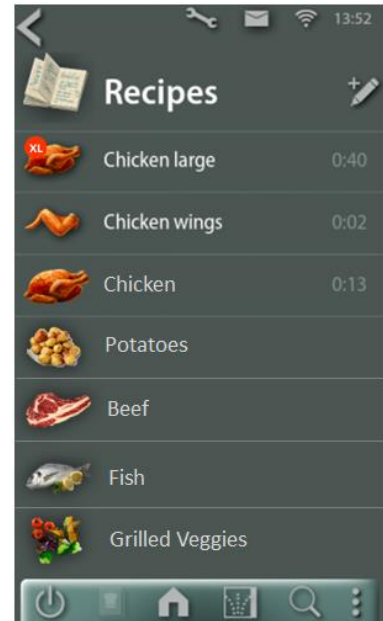

Enter the recipe menu





7.2 Adding programs

1. Select .
2. Enter the program name.
3. Enter the preheat step (or left blank).
4. Add cooking steps (swipe additional step at the bottom of the screen upwards).
5. Once complete press .

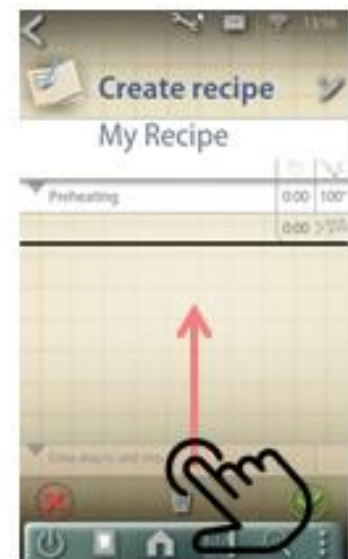
Note: step name can be changed (press on it).



7.3 Edit programs

1. Select recipe to edit.
2. Select .
3. Make required alterations.
4. Once complete press .

7.4 Deleting programs



Deleting of a program cannot be undone.

1. Select recipe to delete.

2. Select .

3. Select .

4. Select Yes.

8. CLEANING AND MAINTENANCE



WARNING

Appliance must be disconnected from the power supply during manual cleaning or maintenance and when replacing parts.

Do not use aggressive or abrasive materials. These will damage the surface which will make it more difficult to remove dirt.

Clean the inside, the removable parts and the accessories thoroughly with cleanser and water before putting the unit into use. Follow the cleaning instructions as described in this chapter.

Treat the outer surface of the interior window with a soft cleaning agent to protect the reflection layer.

Cleaning should not be delayed beyond 8 hours of service.

Wear rubber gloves when cleaning.



WARNING

Never use a water hose for cleaning. Water can seep into the unit through the ventilation holes of the unit.



Descaling functionality is depending on service setting: contact your dealer for more information.

8.1 Maintenance schedule

Item	Action	Frequency
Interior	<ul style="list-style-type: none"> Clean, see section 8.2. 	Daily
Exterior	<ul style="list-style-type: none"> Use Stainless Steel cleaning spray to remove stains, and restoring the gloss, see section 8.3. 	Weekly
Interior	<ul style="list-style-type: none"> Additional Manual Cleaning, see section 8.4. 	Monthly
Interior	<ul style="list-style-type: none"> Professional maintenance: contact your dealer. 	Yearly



For hygiene matters and optimum state of your unit, it is advised to maintain a fixed daily cleaning schedule.

8.2 Daily Cleaning



WARNING

Cool-Down the unit prior starting the cleaning program.



WARNING

Accessories must be removed from the unit during the cleaning program. The rotor itself is meant to be remain in the unit.



WARNING

Opening the door during a cleaning program causes the unit to stop and go to fault state. The program will continue when the door is closed.

Depending the temperatures you are operating on, pollution will be build up in time due of burning in the fat particles on the walls of the Rotisserie.

This building up also occurs when you are using stuffing or marinades in your product.

Cool-down the unit first !

1. Take two cleaning Cartridges *ProteClean*¹.



2. Open the Rotisserie door.
3. Remove the caps of the cartridges.



Don't punch the seal!

4. Place the cartridges upside down in the cartridge holder.
5. Close the door.



6. Press .
7. Select cleaning program: **Daily Clean**.
8. Press continue.



The Rotisserie starts cleaning. The screen shows the status of the program including finish time.

9. When finished remove the cartridges. Dispose the cartridges.
10. Remove the deflector plates and filters and clean them manually.
11. Open the drain filter and clean it with a brush. Push it completely through the drain.
12. Inspect the Rotisserie. Remove any spots or remains in the rotisserie with a cloth.
13. Replace the cleaned filters and deflector plates.



The unit is now ready for use.



WARNING

If the cartridges are not taken out before using the Rotisserie, the plastic will melt and causes smoke and contamination risk.



Contact your supplier for the appropriate *Fri-Jado Rotisserie Cleaning Cartridges*. Additional are *Fri-Jado In Between Clean* and *Fri-Jado RotiShine Descale* cleaning products available. Please contact Fri-Jado for more information.

¹ *ProteClean* disclaimer: In some cases a quick release of the second stage of the product can cause black stains in the stainless steel. This is nothing to worry about. A descale program with *Rotishine* will help to reduce these stains.

8.3 Weekly Cleaning

**WARNING**

The control panel may only be cleaned using a damp cloth.

The exterior:

- Clean the exterior with cleaning agent or hot water combined with an appropriate cleaning agent.
- Dry the exterior thoroughly by using a dry cloth.

8.4 Additional Manual Cleaning



The unit can be cleaned best shortly after use, when it is still lukewarm. Grilling residue and fat can be removed easily in this state.

The best cleaning can be achieved by using special oven- or grill cleaner.

The door has a magnetic lock. Regularly check the surfaces between the door and grill, and clean if necessary, to avoid air leaks.

Glass doors:

- Open the outer glass doors.
- Unlock the inner glass doors (they are magnetically locked to the outer doors).
- Clean the panes with cleaning agent or hot water combined with an appropriate cleaning agent.
- Dry the doors thoroughly by using a dry cloth.
- If possible, leave the glass doors open at night.

9. MALFUNCTIONS AND SERVICE

Before you contact your supplier/dealer in case of a malfunction, there are some items you can check yourself:

- Is the power supply working properly? Check fuses and differential switch.
- Has the timer clock been properly set?

Item	Malfunction	Possible action
Control	Program do not start	<ul style="list-style-type: none"> • Check if both doors are closed correctly.
Cleaning	Leaks water during cleaning	<ul style="list-style-type: none"> • Door not closed correctly.
Cleaning	Oven not clean after cleaning cycle	<ul style="list-style-type: none"> • Not enough detergent, check supply. • No water supply, check. • Drain polluted, clean. • Drain valve not working properly, check.
Lamp	Does not light up	<ul style="list-style-type: none"> • Defect, replace.
Oven	Product is not getting done equally	<ul style="list-style-type: none"> • Try a lower cooking temperature. • Check fuses and/or the differential switch.
Oven	The oven does not heat up	<ul style="list-style-type: none"> • Open and close door. • Check fuses and/or the differential switch.
Mains cord	Damaged	<ul style="list-style-type: none"> • Replace, see section 9.1.

9.1 Replace the mains cord



WARNING

Hazardous electrical voltage.

If the mains cord is damaged, it must be replaced by the manufacturer, his service agent or a similarly qualified person in order to avoid hazards.

10. TECHNICAL SPECIFICATIONS

WARNING

Consult the identification plate to get the proper specifications of the unit. The electrical data may vary from country to country.

Models

Model	LDR 8 s AC	LDR 8+8 s AC
Dimensions		
- Width	55 inch	51 inch
- Depth	38 inch	38 inch
- Height	71 inch	72 inch
Weight		
- Gross	745 lbs.	926 lbs.
- Net	635 lbs.	809 lbs.
Maximum ambient temperature	95 °F	95 °F
Sound pressure	< 70 dB(A)	< 70 dB(A)
Electrical installation		
- Voltage	3~ 208 V	3~ 208 V
- Frequency	50/60 Hz	50/60 Hz
- Required power	20.6 kW	20.6 kW (2x)
- Max. nom. current	60 A	60 A (2x)
Electrical connection	hard wired	hard wired (2x)
Water connection, aerated	¾ inch	¾ inch (1x)
Water pressure	200 – 500 kPa	200 – 500 kPa
Drain, open connection	min. 1 5/8 inch	min. 1 5/8 inch (2x)

Fri-Jado B.V.
Blauwhekken 2
4751 XD Oud Gastel
The Netherlands
Tel: +31 (0) 76 50 85 400

Fri-Jado Inc.
1401 Davey Road, Suite 100
Woodridge IL 60517
USA
Tel: +1-630-633-7950

www.frijado.com